



International

PRICELIST 2020

DESIGN LINE · PREMIUM LINE · COMFORT LINE · X-SERIES

HOT TUB

DESIGN LINE / PREMIUM LINE / COMFORT LINE / X-SERIES

DESIGN LINE - JUST SILENCE & JUST SILENCE COMPACT* (COLOUR COMBINATION: GOODS IN STOCK)

Inside shell

Outer panelling

Covers



Snow



Light Grey



Timber



Ash Grey

* Only available in this colour combination

PREMIUM LINE / COMFORT LINE

Inside shell ¹⁾



Cloud



Granite



Midnight Canyon



Pearl



Platinum



Snow ²⁾



Titanium

Outer panelling ¹⁾



Chestnut ³⁾

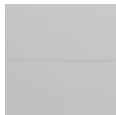

Light Grey ²⁾³⁾

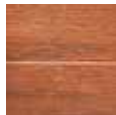

Orchard ²⁾



Stone Grey ²⁾



Timber ³⁾

Covers ¹⁾



Ash Grey

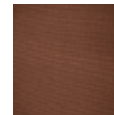

Chocolate

X-SERIES

Inside shell ¹⁾



Cloud



Midnight Canyon



Platinum



Snow

Outer panelling ¹⁾



Stone Grey



Chestnut

Covers ¹⁾

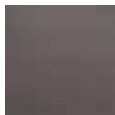

Ash Grey

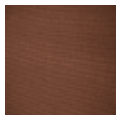

Chocolate

STANDARD COLOUR COMBINATIONS (STOCK ITEMS)

PREMIUM LINE - VARIANT 1

PREMIUM LINE - VARIANT 2

COMFORT LINE

Inside shell

Outer panelling

Covers



Titanium



Timber

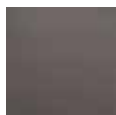

Ash Grey

Inside shell

Outer panelling

Covers



Pearl



Orchard

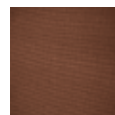

Chocolate

Inside shell

Outer panelling

Covers



Snow



Stone Grey

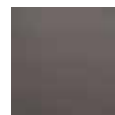

Ash Grey

X-SERIES

Inside shell

Outer panelling

Covers



Platinum



Stone Grey

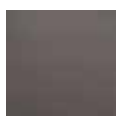

Ash Grey

¹⁾ All colour combinations possible without surcharge

²⁾ Colour combinations not available for A9L

³⁾ Colour combinations not available for Comfort Line

DESIGN LINE / PREMIUM LINE / COMFORT LINE / X-SERIES























- ① Waterfall
- ② Hip jets
- ③ Leg jets
- ④ Wrist jets
- ⑤ Generous foot room with foot jets
- ⑥ Illuminated cup holder
- ⑦ Narrow rim/small radii for generous amount of space
- ⑧ Loudspeaker

- The weight specifications do not include people.
- Capacity: Volume of water in litres when filled to the fill line
- Weight (dry with cover): Weight with cover / without people

EQUIPMENT	JETPAK™ II TECHNOLOGY			STANDARD TECHNOLOGY
	DESIGN LINE	PREMIUM LINE	COMFORT LINE	X-SERIES
Control panel	Just Touch	A900 Premium Colour Control	R600 Comfort Control	X Control
Neck cushion	Design Pillow	Premium Fit Pillow	Comfort Pillow	X Pillow
JetPak™ technology	JP™ II	JP™ II	JP™ II	-
Central LED lighting	with JP™ Logo	with JP™ Logo	with JP™ Logo	standard
Illuminated exterior logo	standard	standard	standard	-
Exterior lighting	standard	standard	-	-
Illuminated Jets	-	-	-	optional
Illuminated foot area	standard	standard	standard	-
Illuminated Filter area	standard	standard	standard	-
Illuminated cup holder	-	standard	-	-
Illuminated additional control panel	-	standard	-	-
Waterfall	Design Waterfall	Cascadia Waterfall	Comfort Waterplay	X-Waterfall
Jet design	standard brushed stainless steel	standard brushed stainless steel	standard grey jets optional brushed stainless steel	standard brushed stainless steel
2-stage pump	standard	standard	standard	depending on model
2.0/2.5 HP pump, depending on model	standard	standard	standard	standard
Ozonator	standard	standard	standard	standard
Stereo System (optional)	Design	Premium	Comfort	X-Stereo
Arm, hip and leg jets	Depending on model	Depending on model	Depending on model	Depending on model
Heating	3 KW	3 KW	3 KW	3 KW
Filter	Two efficient special filters for DESIGN LINE.	Two efficient filters, each with 4.64 m ²	Two efficient filters, each with 4.64 m ²	Two efficient filters, each with 4.64 m ²
License	CE marking, TÜV	CE marking, TÜV	CE marking, TÜV	CE marking, TÜV
Electrical equipment	230 V or 400 V	230 V or 400 V	230 V or 400 V	230 V or 400 V
Energy-saving full-foam insulation	standard	standard	standard	standard
Robust cover	standard	standard	standard	standard
Automatic filter cycles	standard	standard	standard	standard
Exclusive Endura frame design	standard	standard	standard	standard
WiFi module for Smartphone	optional	optional	optional	-

DESIGN LINE / PREMIUM LINE / COMFORT LINE / X-SERIES

	3-SEATER 208 x 169 x 78 cm		5-SEATER 224 x 213 x 86 cm				
DESIGN LINE <ul style="list-style-type: none"> • JetPak™ II technology • Exclusive massage jets in brushed stainless steel • EnduraFrame™ construction • Design Control • 2-stage pump + additional filter pump • LED interior lighting • DESIGN waterfall • DESIGN Neck cushion • Energy-saving full-foam insulation • New seating concept • New interior/exterior design 	 JUST SILENCE COMPACT 3 JetPaks™		 JUST SILENCE 3 JetPaks™				
	3-SEATER 173x213x79 cm	5-SEATER 203x224x86 cm	5-SEATER 239x239x97 cm	6-SEATER 224x224x91 cm	6-SEATER 239x239x97 cm	8-SEATER 239x239x97 cm	8-SEATER 239x279x97 cm
PREMIUM LINE <ul style="list-style-type: none"> • JetPak™ II technology • Maximum number of JetPaks™ • Exclusive massage jets in brushed stainless steel • EnduraFrame™ construction • Premium Control • 2-stage pump (A9L 1-stage and 2-stage) • LED interior lighting • LED Exterior lighting • Cascadia™ waterfall • Premium Neck cushion • Illuminated cup holder • Energy-saving full-foam insulation 	 A5L 3 JetPaks™	 A6L 4 JetPaks™	 A8D 5 JetPaks™	 A7 5 JetPaks™  A7L 5 JetPaks™	 A6L 6 JetPaks™	 A8 6 JetPaks™	 A9L 7 JetPaks™
COMFORT LINE <ul style="list-style-type: none"> • JetPak™ II technology • EnduraFrame™ construction • Comfort Control • 2-stage pump • LED interior lighting • Exclusive massage jets made of synthetic material • Comfort Neck cushion • Comfort water feature • Energy-saving full-foam insulation 	 R5L 2 JetPaks™	 R6L 3 JetPaks™		 R7 4 JetPaks™  R7L 4 JetPaks™	 R8L 4 JetPaks™		
	173x213x79 cm	203x224x86 cm	201 x 91 cm	224x224x91 cm		239x239x97 cm	
X-SERIES <ul style="list-style-type: none"> • Classic Technology • EnduraFrame™ Construction • X-Control • Exclusive massage jets made of Brushed Stainless Steel • Energy-saving full-foam insulation • X-Waterfall 	 X5L	 X6L	 X6R	 X7L		 X8	

DESIGN LINE

JUST SILENCE COMPACT (Rectangle 208 x 169 x 78 cm)

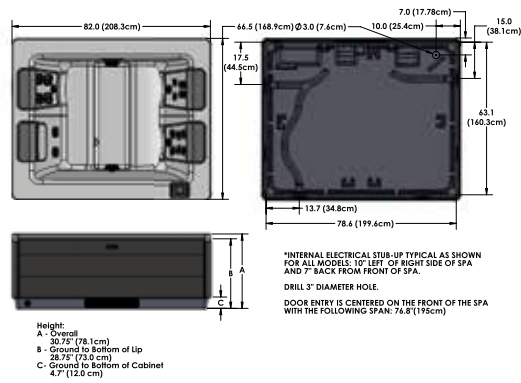

Jet Paks

Design Line Therapy

S02
PulsatorS19
WellnessS12
Spinal
Health

Technical information

Number of recliners/seats	3 seats
Design neck cushion	4 pieces
Weight (dry)	206 kg
Weight (filled to maximum)	1456 kg
Capacity to fill line	947 l
Capacity max.	1299 l
Pump performance	1 pump, 2,5 HP + additional filter pump

Colour combinations

Article number	Version	Shell	Panelling	Cover	Sound System	JetPaks	Jets	Price
USS5DSLA1S44		Snow	Light Grey	Ash Grey				18.800,-
USS5DSTA1S44		Snow	Timber	Ash Grey				18.800,-
USS5DSTA8S44*		Snow	Timber	Ash Grey	Design Audio			20.100,-
USS5DSLA8S44*		Snow	Light Grey	Ash Grey	Design Audio			20.100,-

* This is not a stock item

Prices in Euro and excluding VAT. Delivery costs depend on quantity and type of delivery.

DESIGN LINE



JUST SILENCE (Rectangle 224 x 213 x 86 cm)

DESIGN LINE

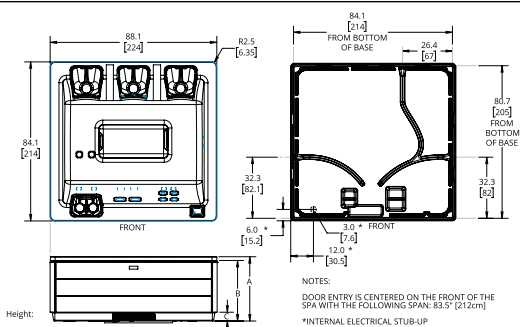

Height:
 A - Overall 86 [21.4cm]
 B - Ground to Bottom of Lip 82 [20.6cm]
 C - Ground to Bottom of Cabinet 86.7 [21.9cm]

NOTES:
 * DOOR ENTRY IS CENTERED ON THE FRONT OF THE SPA WITH THE FOLLOWING SPAN: 83.3* (21.2cm)
 ** INTERNAL ELECTRICAL STUB-UP

Jet Paks

Design Line Therapy

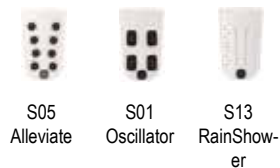

Technical information

Number of recliners/seats	5 seats
Design neck cushion	6 pieces
Weight (dry)	279 kg
Weight (filled to maximum)	1767 kg
Capacity to fill line	1488 l
Capacity max.	2013 l
Pump performance	1 pump, 2,5 HP + additional filter pump

Colour combinations

Article number	Version	Shell	Panelling	Cover	Sound System	JetPaks	Jets	Price
USS7DSL1S44		Snow	Light Grey	Ash Grey				21.600,-
USS7DSTA1S44		Snow	Timber	Ash Grey				21.600,-
USS7DSL1S44		Snow	Light Grey	Ash Grey	Design Audio			22.900,-
USS7DSTA1S44*		Snow	Timber	Ash Grey	Design Audio			22.900,-

ACCESSORIES

Accessories

Article number	Description	Price
U90SP000000	Easy Lifter for easy removal of the cover	300,-
U90SP000002	Hot tub steps, colour Grey	200,-
UCCOM1321	Filterset Design Line (2 replacement filters)	110,-
UCELP0908	WiFi module for Smartphone	500,-
	Design Audio	1.300,-
	EOS - Enhanced Ozone System	650,-

JETPAK II UPGRADE

Design Line Therapy						
Model	S01	S02	S05	S19	S12	S13
Model name	Oscillator	Pulsator	Alleviate	Wellness	Spinal Health	RainShower
Color version	Brushed Stainless Steel	Brushed Stainless Steel	Brushed Stainless Steel	Brushed Stainless Steel	Brushed Stainless Steel	Brushed Stainless Steel
Flow Rate (litres per minute)	174 l/min	265 l/min	220 l/min	186 l/min	159 l/min	
Article number	USJS01S3	USJS02S3	USJS05S3	USJS19S3	USJS12S3	USJS13S3
Price	680,-	780,-	780,-	680,-	580,-	580,-

* This is not a stock item

Prices in Euro and excluding VAT. Delivery costs depend on quantity and type of delivery.

PREMIUM LINE

A5L (Rectangle 173 x 213 x 79 cm)

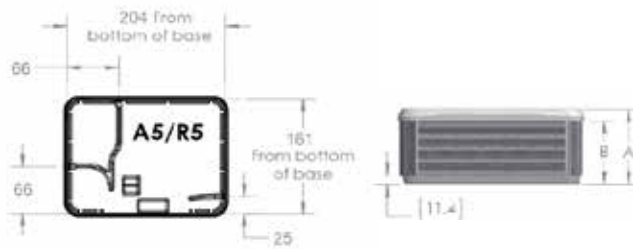

Height ,A' 78,7 cm
Height ,B' 63,5 cm

Jet Paks

Sport Flow Therapy



J02 Pulsator J05 Alleviate

Relax Flow Therapy



J13 RainShower

Technical information

Number of recliners/seats	1/2 seats
Premium neck cushion	3 pieces
Weight (dry)	206 kg
Weight (filled to maximum)	1126 kg
Capacity to fill line	920 l
Capacity max.	1250 l
Pump performance	1 pump, 2,5 HP

Colour combinations

Article number	Version	Shell	Panelling	Cover	Sound System	JetPaks	Jets	Price
USA5LPOC1145		Pearl	Orchard	Chocolate		Pearl		15.850,-
USA5LITA1145		Titanium	Timber	Ash Grey		Titanium		15.850,-

A6L (Rectangle 203 x 224 x 86 cm)

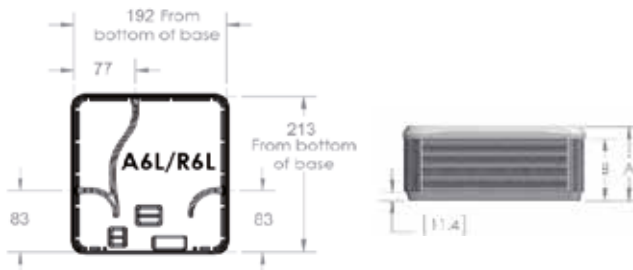

Height ,A' 86,4 cm
Height ,B' 71,1 cm

Jet Paks

Sport Flow Therapy



J03 DeepRelief

Wellness Flow Therapy



J06 Neck Masseuse J07 Fibro Therapy

Relax Flow Therapy



J13 RainShower

Technical information

Number of recliners/seats	1/4 seats
Premium neck cushion	4 pieces
Weight (dry)	261 kg
Weight (filled to maximum)	1585 kg
Capacity to fill line	1324 l
Capacity max.	1804 l
Pump performance	1 pump, 2,5 HP

Colour combinations

Article number	Version	Shell	Panelling	Cover	Sound System	JetPaks	Jets	Price
USA6LPOC1145		Pearl	Orchard	Chocolate				17.800,-
USA6LITA1145		Titanium	Timber	Ash Grey				17.800,-

* This is not a stock item

Prices in Euro and excluding VAT. Delivery costs depend on quantity and type of delivery.

PREMIUM LINE

A7 (Square 224 x 224 x 91 cm)

PREMIUM LINE

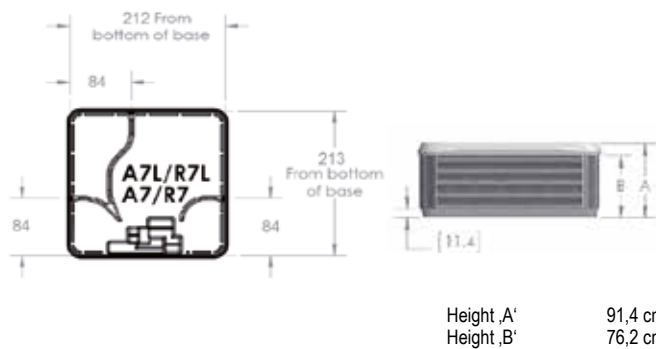

Height ,A' 91,4 cm
Height ,B' 76,2 cm

Jet Paks

Sport Flow Therapy



J03 DeepRelief J11 Gyro'ssage

Wellness Flow Therapy



J06 Neck Masseuse

Relax Flow Therapy



J12 Spinal Health J13 RainShower

Technical information

Number of recliners/seats	0/6 seats
Premium neck cushion	5 pieces
Weight (dry)	300 kg
Weight (filled to maximum)	1943 kg
Capacity to fill line	1643 l
Capacity max.	2111 l
Pump performance	2 pumps, 2 HP

Colour combinations

Article number	Version	Shell	Panelling	Cover	Sound System	JetPaks	Jets	Price
*		individual colour selection	individual colour selection	individual colour selection				20.400,-

A7L (Square 224 x 224 x 91 cm)

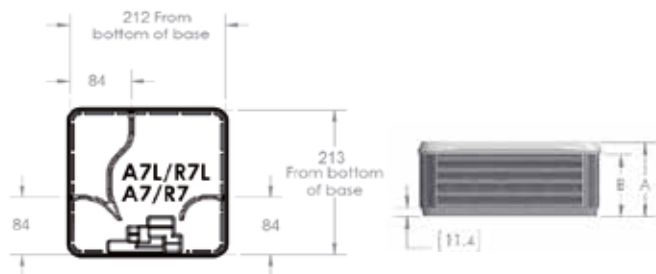

Height ,A' 91,4 cm
Height ,B' 76,2 cm

Jet Paks

Sport Flow Therapy



J05 Alleviate J11 Gyro'ssage

Wellness Flow Therapy



J06 Neck Masseuse

Relax Flow Therapy



J08 Lumbar J13 RainShower

Technical information

Number of recliners/seats	1/5 seats
Premium neck cushion	5 pieces
Weight (dry)	308 kg
Weight (filled to maximum)	1974 kg
Capacity to fill line	1666 l
Capacity max.	2067 l
Pump performance	2 pumps, 2 HP

Colour combinations

Article number	Version	Shell	Panelling	Cover	Sound System	JetPaks	Jets	Price
USA7LPOC1145		Pearl	Orchard	Chocolate		Pearl		20.400,-
USA7LITA1145		Titanium	Timber	Ash Grey		Titanium		20.400,-

* This is not a stock item

Prices in Euro and excluding VAT. Delivery costs depend on quantity and type of delivery.

PREMIUM LINE

A8D (Square 239 x 239 x 97 cm)

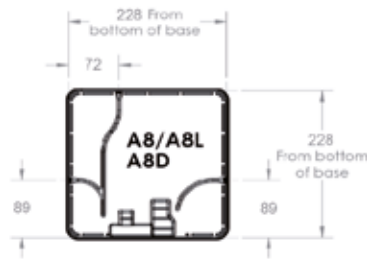

Height ,A' 96,5 cm
Height ,B' 81,3 cm

Jet Paks

Sport Flow Therapy



J11 Gyro'ssage

Wellness Flow Therapy



J01 Oscillator



J06 Neck Masseur



J16 Cascadia

Relax Flow Therapy



J13 RainShower

Technical information	
Number of recliners/seats	2/3 seats
Premium neck cushion	5 pieces
Weight (dry)	346 kg
Weight (filled to maximum)	2284 kg
Capacity to fill line	1938 l
Capacity max.	2450 l
Pump performance	2 pumps, 2 HP

Colour combinations								
Article number	Version	Shell	Panelling	Cover	Sound System	JetPaks	Jets	Price
USA8DPOC1145		Pearl	Orchard	Chocolate				22.700,-
USA8DITA1145		Titanium	Timber	Ash Grey				22.700,-

A8L (Square 239 x 239 x 97 cm)

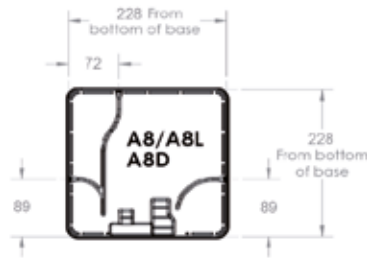

Height ,A' 96,5 cm
Height ,B' 81,3 cm

Jet Paks

Sport Flow Therapy



J11 Gyro'ssage

Wellness Flow Therapy



J01 Oscillator



J06 Neck Masseur



J16 Cascadia

Relax Flow Therapy



J12 Spinal Health



J13 RainShower

Technical information	
Number of recliners/seats	1/5 seats
Premium neck cushion	6 pieces
Weight (dry)	353 kg
Weight (filled to maximum)	2388 kg
Capacity to fill line	2044 l
Capacity max.	2503 l
Pump performance	2 pumps, 2 HP

Colour combinations								
Article number	Version	Shell	Panelling	Cover	Sound System	JetPaks	Jets	Price
*		individual colour selection	individual colour selection	individual colour selection				23.600,-

* This is not a stock item

Prices in Euro and excluding VAT. Delivery costs depend on quantity and type of delivery.

PREMIUM LINE

A8 (Square 239 x 239 x 97 cm)

PREMIUM LINE

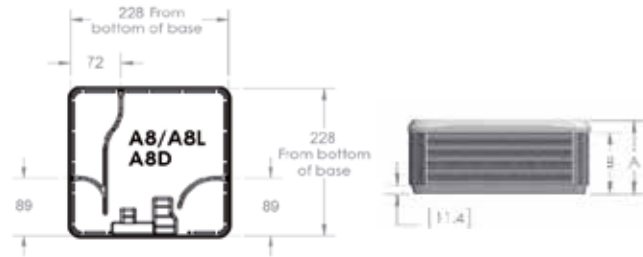

Height ,A' 96,5 cm
Height ,B' 81,3 cm

Jet Paks

Sport Flow Therapy

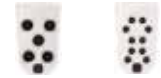

J11 Gyro'ssage J03 DeepRelief

Wellness Flow Therapy



J06 Neck Masseur J16 Cascadia

Relax Flow Therapy



J10 Spinal'ssage J13 RainShower

Technical information

Number of recliners/seats	0/8 seats
Premium neck cushion	6 pieces
Weight (dry)	344 kg
Weight (filled to maximum)	2388 kg
Capacity to fill line	2049 l
Capacity max.	2563 l
Pump performance	2 pumps, 2 HP

Colour combinations

Article number	Version	Shell	Panelling	Cover	Sound System	JetPaks	Jets	Price
*		individual colour selection	individual colour selection	individual colour selection				23.800,-

A9L (Rectangle 239 x 279 x 97 cm)

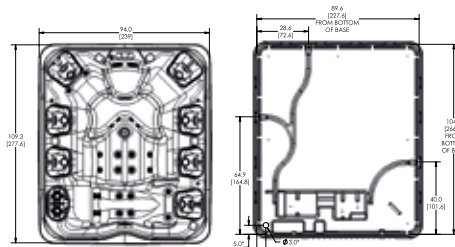

Height ,A' 96,5 cm
Height ,B' 81,3 cm

Jet Paks

Sport Flow Therapy



J02 Pulsator J03 DeepRelief

Wellness Flow Therapy



J06 Neck Masseur J14 Versa J21 Trio

Relax Flow Therapy



J08 Lumbar J13 RainShower

Technical information

Number of recliners/seats	1/7 seats
Premium neck cushion	7 pieces
Weight (dry)	413 kg
Weight (filled to maximum)	3147 kg
Capacity to fill line	2161 l
Capacity max.	2816 l
Pump performance	3 pumps, 2 HP

Colour combinations

Article number	Version	Shell	Panelling	Cover	Sound System	JetPaks	Jets	Price
USA9LITA1145		Titanium	Timber	Ash Grey				26.000,-

* This is not a stock item

Prices in Euro and excluding VAT. Delivery costs depend on quantity and type of delivery.

PREMIUM LINE

A6L (Rectangle 203 x 224 x 86 cm) Fitness Edition

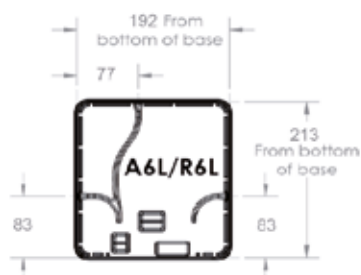

Height ,A' 86,4 cm
Height ,B' 71,1 cm

Jet Paks

Sport Flow Therapy



J02 Pulsator



J03 DeepRelief



J04 Neck Blaster

Wellness Flow Therapy



J21 Trio

Technical information

Number of recliners/seats	1/4 seats
Premium neck cushion	4 pieces
Weight (dry)	288 kg
Weight (filled to maximum)	1612 kg
Capacity to fill line	1324 l
Capacity max.	1804 l
Pump performance	2 pumps, 2 HP (Minimum of a 3 x 16A or 2 x 16A fuse connection required / Limited functionality only on a 1 x 16A fuse)

Colour combinations

Article number	Version	Shell	Panelling	Cover	Sound System	JetPaks	Jets	Price
USA6LSTA114E	Fitness Edition	Snow	Timber	Ash Grey				19.300,-

A7L (Square 224 x 224 x 91 cm) Fitness Edition

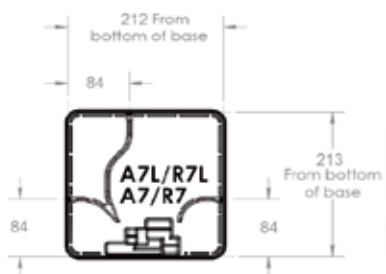

Height ,A' 91,4 cm
Height ,B' 76,2 cm

Jet Paks

Sport Flow Therapy



J02 Pulsator



J03 DeepRelief



J04 Neck Blaster

Wellness Flow Therapy



J14 Versa



J21 Trio

Technical information

Number of recliners/seats	1/5 seats
Premium neck cushion	5 pieces
Weight (dry)	308 kg
Weight (filled to maximum)	1974 kg
Capacity to fill line	1666 l
Capacity max.	2067 l
Pump performance	2 pumps, 2,5 HP (Minimum of a 3 x 16A fuse connection required)

Colour combinations

Article number	Version	Shell	Panelling	Cover	Sound System	JetPaks	Jets	Price
USA7LSTA114E	Fitness Edition	Snow	Timber	Ash Grey				21.100,-

* This is not a stock item

Prices in Euro and excluding VAT. Delivery costs depend on quantity and type of delivery.

PREMIUM LINE

A8D (Square 239 x 239 x 97 cm) Fitness Edition

PREMIUM LINE

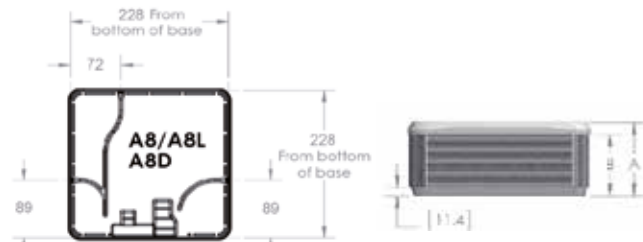

Height ,A' 96,5 cm
Height ,B' 81,3 cm

Jet Paks

Sport Flow Therapy

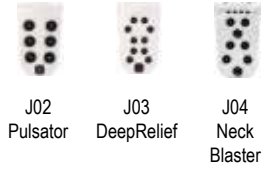

Wellness Flow Therapy



Technical information

Number of recliners/seats	2/3 seats
Premium neck cushion	5 pieces
Weight (dry)	346 kg
Weight (filled to maximum)	2284 kg
Capacity to fill line	1938 l
Capacity max.	2450 l
Pump performance	2 pumps, 2,5 HP (Minimum of a 3 x 16A fuse connection required)

Colour combinations

Article number	Version	Shell	Panelling	Cover	Sound System	JetPaks	Jets	Price
USA8DSTA114E	Fitness Edition	Snow	Timber	Ash Grey				23.400,-

A9L (Rectangle 239 x 279 x 97 cm) Fitness Edition

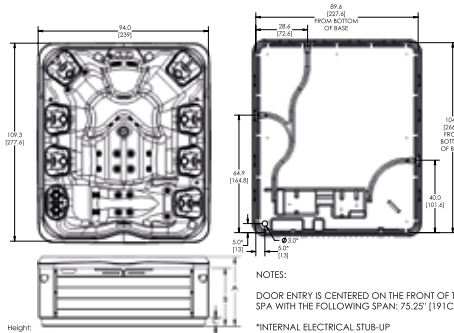

Height ,A' 96,5 cm
Height ,B' 81,3 cm

Jet Paks

Sport Flow Therapy

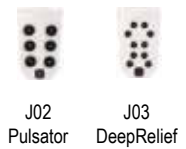

Wellness Flow Therapy



Relax Flow Therapy



Technical information

Number of recliners/seats	1/7 seats
Premium neck cushion	7 pieces
Weight (dry)	413 kg
Weight (filled to maximum)	3147 kg
Capacity to fill line	2161 l
Capacity max.	2816 l
Pump performance	3 pumps, 2 HP (Minimum of a 3 x 16A fuse connection required)

Colour combinations

Article number	Version	Shell	Panelling	Cover	Sound System	JetPaks	Jets	Price
USA9LSTA1145	Fitness Edition	Snow	Timber	Ash Grey				26.000,-

* This is not a stock item

Prices in Euro and excluding VAT. Delivery costs depend on quantity and type of delivery.

COMFORT LINE

R5L (Rectangle 173 x 213 x 79 cm)

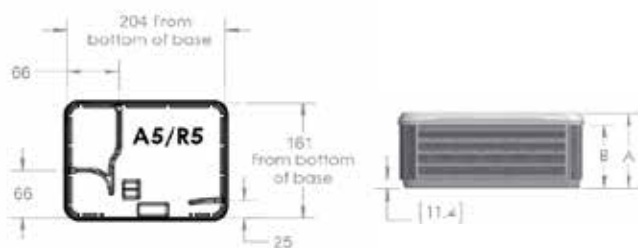

Height ,A' 78,7 cm
Height ,B' 63,5 cm

Jet Paks

Wellness Flow Therapy



J20
Reliever

Relax Flow Therapy



J13
RainShower

Technical information

Number of recliners/seats	1/2 seats
Comfort neck cushion	2 pieces
Weight (dry)	206 kg
Weight (filled to maximum)	1096 kg
Capacity to fill line	890 l
Capacity max.	1212 l
Pump performance	1 pump, 2,5 HP

Colour combinations

Article number	Version	Shell	Panelling	Cover	Sound System	JetPaks	Jets	Price
USR5LSSA1124		Snow	Stone Grey	Ash Grey			Grey	12.450,-

R6L (Rectangle 203 x 224 x 86 cm)

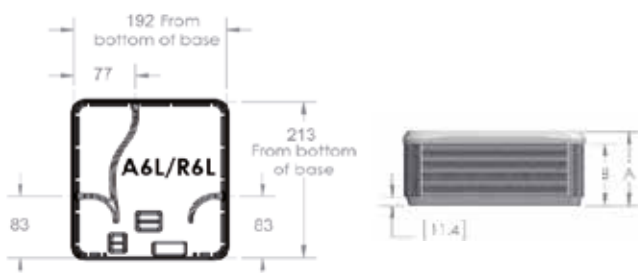

Height ,A' 86,4 cm
Height ,B' 71,1 cm

Jet Paks B&W

Sport Flow Therapy



J05
Alleviate

Wellness Flow Therapy



J01
Oscillator

Relax Flow Therapy



J13
RainShower

Jet Paks R6L



J05
Alleviate



J06
Neck
Masseur



J13
RainShower

Technical information

Number of recliners/seats	1/4 seats
Comfort neck cushion	3 pieces
Weight (dry)	261 kg
Weight (filled to maximum)	1556 kg
Capacity to fill line	1295 l
Capacity max.	1766 l
Pump performance	1 pump, 2,5 HP

Colour combinations

Article number	Version	Shell	Panelling	Cover	Sound System	JetPaks	Jets	Price
USR6LSSA1124		Snow	Stone Grey	Ash Grey			Grey	13.750,-
USR6LSSA1D44	Black & White	Snow	Stone Grey	Ash Grey		Dark Grey	Brushed Stainless Steel	14.150,-

* This is not a stock item

Prices in Euro and excluding VAT. Delivery costs depend on quantity and type of delivery.

COMFORT LINE

R7 (Square 224 x 224 x 91 cm)

COMFORT LINE

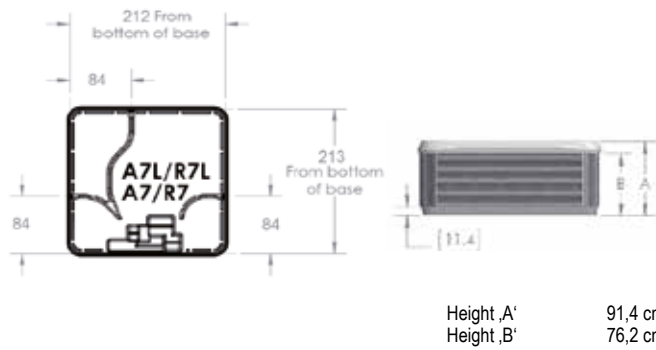

Jet Paks

Wellness Flow Therapy

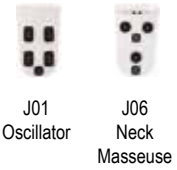

Relax Flow Therapy



Technical information

Number of recliners/seats	0/6 seats
Comfort neck cushion	4 pieces
Weight (dry)	300 kg
Weight (filled to maximum)	1935 kg
Capacity to fill line	1635 l
Capacity max.	2051 l
Pump performance	2 pumps, 2 HP

Colour combinations

Article number	Version	Shell	Panelling	Cover	Sound System	JetPaks	Jets	Price
*		individual colour selection	individual colour selection	individual colour selection				16.350,-

R7L (Square 224 x 224 x 91 cm)

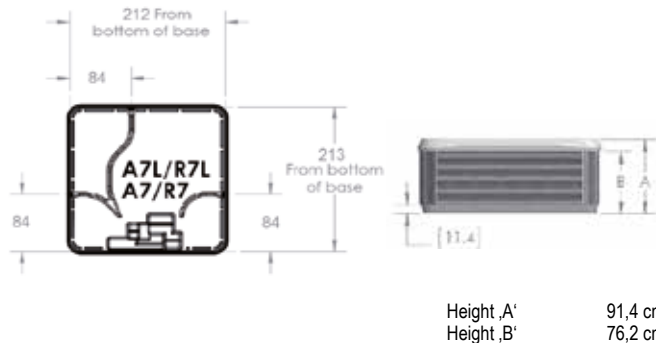

Jet Paks

Sport Flow Therapy



Wellness Flow Therapy

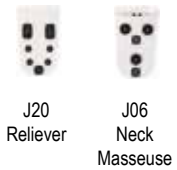

Relax Flow Therapy



Technical information

Number of recliners/seats	1/5 seats
Comfort neck cushion	4 pieces
Weight (dry)	308 kg
Weight (filled to maximum)	1921 kg
Capacity to fill line	1613 l
Capacity max.	2029 l
Pump performance	2 pumps, 2 HP

Colour combinations

Article number	Version	Shell	Panelling	Cover	Sound System	JetPaks	Jets	Price
USR7LSSA1124		Snow	Stone Grey	Ash Grey			Grey	16.350,-

* This is not a stock item

Prices in Euro and excluding VAT. Delivery costs depend on quantity and type of delivery.

COMFORT LINE

R8L (Square 239 x 239 x 97 cm)

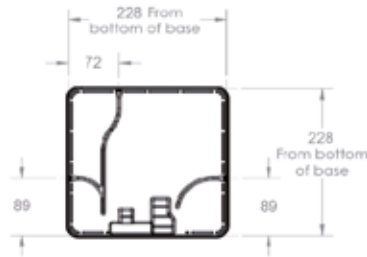

Height ,A' 96,5 cm
Height ,B' 81,3 cm

Jet Paks

Sport Flow Therapy



J03
DeepRelief

Wellness Flow Therapy



J19
Wellness



J06
Neck
Masseur

Relax Flow Therapy



J13
RainShower

Technical information

Number of recliners/seats	1/5 seats
Comfort neck cushion	4 pieces
Weight (dry)	353 kg
Weight (filled to maximum)	2690 kg
Capacity to fill line	1984 l
Capacity max.	2408 l
Pump performance	2 pumps, 2 HP

Colour combinations

Article number	Version	Shell	Panelling	Cover	Sound System	JetPaks	Jets	Price
*		individual colour selection	individual colour selection	individual colour selection				20.100,-

* This is not a stock item



Prices in Euro and excluding VAT. Delivery costs depend on quantity and type of delivery.

ACCESSORIES PREMIUM & COMFORT LINE & BLACK & WHITE EDITION





JETPAK II UPGRADE (no stock items)

Sport Flow Therapy								
								
Model	J02		J03		J04 *		J05	
Model name	Pulsator		DeepRelief		Neck Blaster		Alleviate	
Color version	Grey jets	Brushed Stainless Steel	Grey jets	Brushed Stainless Steel	Grey jets	Brushed Stainless Steel	Grey jets	Brushed Stainless Steel
Flow Rate (litres per minute)	265 l/min		239 l/min		326 l/min		220 l/min	
Article number	USJJ02X1	USJJ02X3	USJJ03X1	USJJ03X3	USJJ04X1	USJJ04X3	USJJ05X1	USJJ05X3
Price	730,-	780,-	730,-	780,-	730,-	780,-	730,-	780,-

Sport Flow Therapy				
				
Model	J11		J17	
Model name	Gyro'ssage		AcuTherapy	
Color version	Grey jets	Brushed Stainless Steel	Grey jets	Brushed Stainless Steel
Flow Rate (litres per minute)	220 l/min		231 l/min	
Article number	USJJ11X1	USJJ11X3	USJJ17X1	USJJ17X3
Price	730,-	780,-	730,-	780,-

Wellness Flow Therapy								
								
Model	J01		J06 *		J07		J14	
Model name	Oscillator		Neck Masseuse		Fibro Therapy		Versa	
Color version	Grey jets	Brushed Stainless Steel	Grey jets	Brushed Stainless Steel	Grey jets	Brushed Stainless Steel	Grey jets	Brushed Stainless Steel
Flow Rate (litres per minute)	174 l/min		178 l/min		212 l/min		189 l/min	
Article number	USJJ01X1	USJJ01X3	USJJ06X1	USJJ06X3	USJJ07X1	USJJ07X3	USJJ14X1	USJJ14X3
Price	630,-	680,-	630,-	680,-	630,-	680,-	630,-	680,-

Wellness Flow Therapy								
								
Model	J16 *		J19		J20		J21	
Model name	Cascadia		Wellness		Reliever		Trio	
Color version	Grey jets	Brushed Stainless Steel	Grey jets	Brushed Stainless Steel	Grey jets	Brushed Stainless Steel	Grey jets	Brushed Stainless Steel
Flow Rate (litres per minute)	163 l/min		186 l/min		208 l/min			
Article number	USJJ16X1	USJJ16X3	USJJ19X1	USJJ19X3	USJJ20X1	USJJ20X3	USJJ21X1	USJJ21X3
Price	630,-	680,-	630,-	680,-	630,-	680,-	630,-	680,-

Relax Flow Therapy								
								
Model	J08		J10		J12		J13	
Model name	Lumbar		Spinal'ssage		Spinal Health		RainShower	
Color version	Grey jets	Brushed Stainless Steel	Grey jets	Brushed Stainless Steel	Grey jets	Brushed Stainless Steel	Grey jets	Brushed Stainless Steel
Flow Rate (litres per minute)	136 l/min		87 l/min		159 l/min			
Article number	USJJ08X1	USJJ08X3	USJJ10X1	USJJ10X3	USJJ12X1	USJJ12X3	USJJ13X1	USJJ13X3
Price	530,-	580,-	530,-	580,-	530,-	580,-	530,-	580,-

* Not available for Black & White Edition / Dark Grey



replace X with colour code: E = Cloud R = Granite L = Platinum M = Midnight Canyon P = Pearl S = Snow I = Titanium D = Dark Grey

Prices in Euro and excluding VAT. Delivery costs depend on quantity and type of delivery.

ACCESSORIES PREMIUM & COMFORT LINE & BLACK & WHITE EDITION

JETPAK II UPGRADE (stock items)

Sport Flow Therapy						
						
Model	J02		J03		J04 *	
Model name	Pulsator		DeepRelief		Neck Blaster	
Color version	Grey jets	Brushed Stainless Steel	Grey jets	Brushed Stainless Steel	Grey jets	Brushed Stainless Steel
Flow Rate (litres per minute)	265 l/min		239 l/min		326 l/min	
Article number	USJJ02X1	USJJ02X3	USJJ03X1	USJJ03X3	USJJ04X1	USJJ04X3
Price	730,-	780,-	730,-	780,-	730,-	780,-

Wellness Flow Therapy						
						
Model	J01		J14		J21	
Model name	Oscillator		Versa		Trio	
Color version	Grey jets	Brushed Stainless Steel	Grey jets	Brushed Stainless Steel	Graue Jets	Brushed Stainless Steel
Flow Rate (litres per minute)	174 l/min		189 l/min			
Article number	USJJ01X1	USJJ01X3	USJJ14X1	USJJ14X3	USJJ21X1	USJJ21X3
Price	630,-	680,-	630,-	680,-	630,-	680,-

* Not available for Black & White Edition / Dark Grey

replace X with colour code (only available in these colors):

Brushed Stainless Steel Jets: P = Pearl I = Titanium
 Grey Jets: S = Snow

ACCESSORIES

Accessories		
Article number	Description	Price
U90SP000000	Easy Lifter for easy removal of the cover	300,-
U90SP000011	Cover Lifter Hydro	450,-
U90SP000012	Easy Cover Lifter for A9L (Set)	400,-
U90SP000013	Cover Lifter Hydro for A9L (Set)	590,-
U90SP000002	Hot tub steps, colour Grey	200,-
U90SP000004	Hot tub steps, colour Brown	200,-
UCCOM1320	Filterset for Premium Line, Comfort Line and X-series (2 replacement filters)	110,-
UCELP0908	WiFi module for Smartphone	500,-
	Premium Audio	1.300,-
	Comfort Audio	1.300,-
	Brushed Stainless Steel Jets for Comfort Line	400,-
	Upgrade pump performance to 2 x 2,5 HP (possible for Spa's with 2 pumps (2 x 2,0 HP)-compellingly 400 Volt 3-phase necessary)	400,-
	Second pump for A6L, R6L	1.200,-
	EOS - Enhanced Ozone System	650,-

X-SERIES

X5L (Rectangle 173 x 213 x 79 cm)

X-SERIES

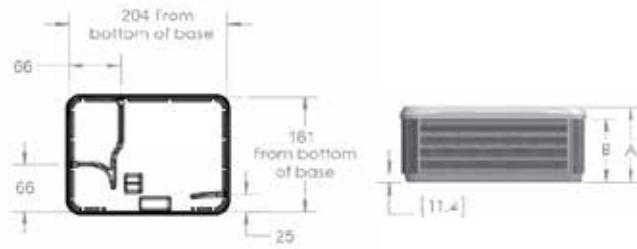

Height ,A' 78,7 cm
Height ,B' 63,5 cm

Technical information

Number of recliners/seats	1/2 seats
Comfortable neck cushion	3 pieces
Weight (dry)	206 kg
Weight (filled to maximum)	1096 kg
Capacity to fill line	890 l
Capacity max.	1212 l
Pump performance	1 pump, 2,5 HP

Colour combinations

Article number	Version	Shell	Panelling	Cover	Sound System	JetPaks	Jets	Price
USX5LLSA1044		Platinum	Stone Grey	Ash Grey			Brushed Stainless Steel	10.500,-

X6L (Rectangle 203 x 224 x 86 cm)

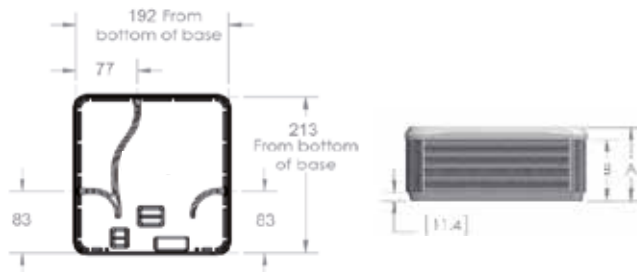

Height ,A' 86,4 cm
Height ,B' 71,1 cm

Technical information

Number of recliners/seats	1/4 seats
Comfortable neck cushion	4 pieces
Weight (dry)	260 kg
Weight (filled to maximum)	1449 kg
Capacity to fill line	1189 l
Capacity max.	1684 l
Pump performance	1 pump, 2,5 HP

Colour combinations

Article number	Version	Shell	Panelling	Cover	Sound System	JetPaks	Jets	Price
USX6LLSA1044		Platinum	Stone Grey	Ash Grey			Brushed Stainless Steel	11.700,-

* This is not a stock item

Prices in Euro and excluding VAT. Delivery costs depend on quantity and type of delivery.

X-SERIES

X7L (Square 224 x 224 x 91 cm)

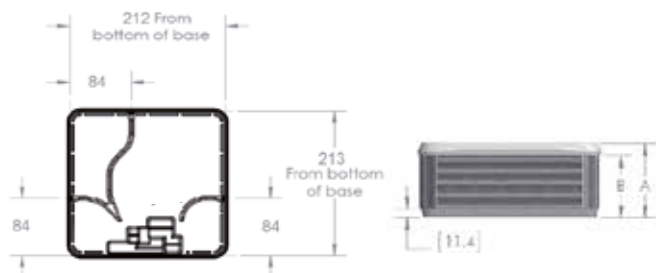

Height ,A' 91,4 cm
Height ,B' 76,2 cm

Technical information

Number of recliners/seats	1/5 seats
Comfortable neck cushion	4 pieces
Weight (dry)	308 kg
Weight (filled to maximum)	1781 kg
Capacity to fill line	1473 l
Capacity max.	1926 l
Pump performance	2 pumps, 2 HP

Colour combinations

Article number	Version	Shell	Panelling	Cover	Sound System	JetPaks	Jets	Price
USX7LLSA1044		Platinum	Stone Grey	Ash Grey			Brushed Stainless Steel	14.000,-

X6R (Round 201 x 91 cm)

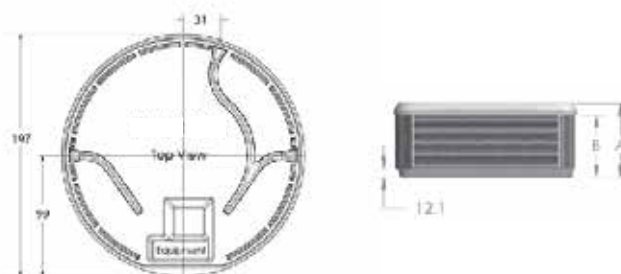

Height ,A' 91 cm
Height ,B' 79 cm

Technical information

Number of recliners/seats	0/5 seats
Weight (dry)	228 kg
Weight (filled to maximum)	1330 kg
Capacity to fill line	1102 l
Capacity max.	1300 l
Pump performance	1 pump, 2,5 HP

Colour combinations

Article number	Version	Shell	Panelling	Cover	Sound System	JetPaks	Jets	Price
USX6RLSA1044		Platinum	Stone Grey	Ash Grey			Brushed Stainless Steel	11.150,-

* This is not a stock item

Prices in Euro and excluding VAT. Delivery costs depend on quantity and type of delivery.

X-SERIES

X8 (Square 239 x 239 x 97 cm)

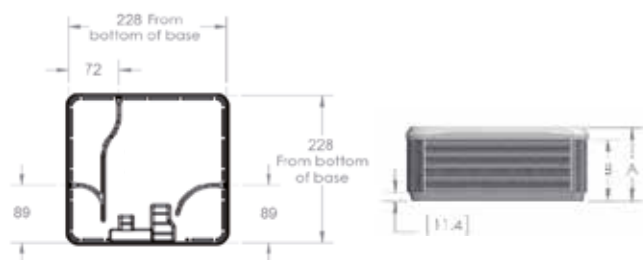

Height ,A'
Height ,B'

96,5 cm
81,3 cm

Technical information

Number of recliners/seats	8 seats
Comfortable neck cushion	4 pieces
Weight (dry)	344 kg
Weight (filled to maximum)	2184 kg
Capacity to fill line	1840 l
Capacity max.	2314 l
Pump performance	2 pumps, 2 HP

Colour combinations

Article number	Version	Shell	Panelling	Cover	Sound System	JetPaks	Jets	Price
*		individual colour selection	individual colour selection	individual colour selection			Brushed Stainless Steel	16.550,-

ACCESSORIES

Accessories

Article number	Description	Price
U90SP000000	Easy Lifter for easy removal of the cover	300,-
U90SP000010	Easy Lifter Flex	500,-
U90SP000002	Hot tub steps, colour Grey	200,-
U90SP000004	Hot tub steps, colour Brown	200,-
UCCOM1320	Filterset for Premium Line, Comfort Line and X-series (2 replacement filters)	110,-
UCELP0908	WiFi module for Smartphone	500,-
	X-Audio	1.200,-

* This is not a stock item

Prices in Euro and excluding VAT. Delivery costs depend on quantity and type of delivery.

Order form X-Series

Wellness dealer:: _____

Name: _____

Address: _____

Postcode, town/city: _____

Telephone: _____

Fax: _____

Mobile: _____

Order number: _____

Date/signature: _____

Contact person / consultant: _____

Name: _____

Address: _____

Postcode, town/city: _____

Telephone: _____

Fax: _____

Mobile: _____

Order number: _____

Date/signature: _____

Step 1: Hot tub		
<i>Please tick the model you require:</i>		
Model	Dimensions	
X5L	173 x 213 x 79 cm	<input type="checkbox"/>
X6L	203 x 224 x 86 cm	<input type="checkbox"/>
X6R	201 x 91 cm	<input type="checkbox"/>
X7L	224 x 224 x 91 cm	<input type="checkbox"/>
X8	239 x 239 x 97 cm	<input type="checkbox"/>

Step 2: Colour of the shell	
<i>Please tick the colour you require:</i>	
Platinum	<input type="checkbox"/>
Midnight Canyon	<input type="checkbox"/>
Snow	<input type="checkbox"/>

Step 3: Colour of the outer panelling	
<i>Please tick the colour you require:</i>	
Stone Grey	<input type="checkbox"/>
Chestnut	<input type="checkbox"/>

Step 4: Colour of the cover	
<i>Please tick the colour you require:</i>	
Ash Grey	<input type="checkbox"/>
Chocolate	<input type="checkbox"/>

Step 5: Special Features	
<i>Please tick the special features you require:</i>	
X-Audio (not for X6R)	<input type="checkbox"/>

Extras:

Please send the form to your area sales representative or the in-house sales staff.

Order form Premium & Comfort Line

Wellness dealer:: _____

Name: _____

Address: _____

Postcode, town/city: _____

Telephone: _____

Fax: _____

Mobile: _____

Order number: _____

Date/signature: _____

Contact person / consultant: _____

Name: _____

Address: _____

Postcode, town/city: _____

Telephone: _____

Fax: _____

Mobile: _____

Order number: _____

Date/signature: _____

Step 1: Hot tub		
Please tick the model you require:		
Model	Dimensions	
A5L	173 x 213 x 79 cm	<input type="checkbox"/>
A6L	203 x 224 x 86 cm	<input type="checkbox"/>
A7	224 x 224 x 91 cm	<input type="checkbox"/>
A7L	224 x 224 x 91 cm	<input type="checkbox"/>
A8D	239 x 239 x 97 cm	<input type="checkbox"/>
A8L	239 x 239 x 97 cm	<input type="checkbox"/>
A8	239 x 239 x 97 cm	<input type="checkbox"/>
A9L	239 x 279 x 97 cm	<input type="checkbox"/>
R5L	173 x 213 x 79 cm	<input type="checkbox"/>
R6L	203 x 224 x 86 cm	<input type="checkbox"/>
R7	224 x 224 x 91 cm	<input type="checkbox"/>
R7L	224 x 224 x 91 cm	<input type="checkbox"/>
R8L	239 x 239 x 97 cm	<input type="checkbox"/>

Step 2: Colour of the shell		
Please tick the colour you require:		
Cloud ¹⁾		<input type="checkbox"/>
Granite		<input type="checkbox"/>
Midnight Canyon		<input type="checkbox"/>
Pearl		<input type="checkbox"/>
Platinum		<input type="checkbox"/>
Snow		<input type="checkbox"/>
Titanium		<input type="checkbox"/>

Step 3: Colour of the outer panelling		
Please tick the colour you require:		
Chestnut ¹⁾		<input type="checkbox"/>
Light Grey ¹⁾²⁾		<input type="checkbox"/>
Orchard ²⁾		<input type="checkbox"/>
Stone Grey ¹⁾		<input type="checkbox"/>
Timber ²⁾		<input type="checkbox"/>

Step 4: Colour of the cover		
Please tick the colour you require:		
Ash Grey		<input type="checkbox"/>
Chocolate		<input type="checkbox"/>

Step 5: music/app		
Please tick the music/app you require:		
No Audio. No WIFI-Module for Smartphone		<input type="checkbox"/>
Premium Audio without WIFI-Modul for Smartphone		<input type="checkbox"/>
Comfort Audio without WIFI-Modul for Smartphone		<input type="checkbox"/>
Premium Audio with WIFI-Modul for Smartphone		<input type="checkbox"/>
Comfort Audio with WIFI-Modul for Smartphone		<input type="checkbox"/>

Step 6: Colour of the Jet Paks		
Please tick the colour you require:		
Platinum		<input type="checkbox"/>
Midnight Canyon		<input type="checkbox"/>
Pearl		<input type="checkbox"/>
Snow		<input type="checkbox"/>
Dark Grey (not for J04, J06, J16)		<input type="checkbox"/>
Titanium		<input type="checkbox"/>
Cloud		<input type="checkbox"/>
Granite		<input type="checkbox"/>

Step 7: Colour of the jets		
Please tick the colour you require:		
Grey Jets (standard Comfort Line), not for Premium Line		<input type="checkbox"/>
Brushed stainless steel Jets		<input type="checkbox"/>

Step 8: Upgrades		
Possible for Spa's with 2 pumps (2 x 2,0 HP)-compellingly 400 Volt 3-phase necessary		
Upgrade pump performance to 2 x 2,5 HP		<input type="checkbox"/>
EOS - Enhanced Ozone System		<input type="checkbox"/>
Second pump for A6L/R6L		<input type="checkbox"/>

¹⁾ Colour combinations not available for A9L. ²⁾ Colour combinations not available for Comfort Line.

Extras:

Please send the form to your area sales representative or the in-house sales staff.

GENERAL SALES CONDITIONS OF VILLEROY & BOCH AG

Bath and Wellness Division - Rev. August 2016

I. General

- These General Conditions of Sale (hereinafter referred to as "conditions of sale") shall apply to all – i. e. also to future – quotations, supply and other performance by Villeroy & Boch AG including all its branches and group companies (hereinafter referred to as "we", "us" or "ourselves"), to customers who are not consumers within the meaning of § 13 of the German Civil Code BGB (hereinafter referred to as "purchasers"; the purchaser and ourselves taken together also being referred to hereinafter as "the parties").
- These conditions of sale shall, unless any other provision is expressly made, apply for the entire duration of the business relationship without its being necessary for us to make specific reference to the fact. Business conditions of the purchaser shall not apply unless expressly recognised by ourselves in writing. These conditions of sale shall also apply if we make deliveries to the purchaser unconditionally while aware of conditions of the purchaser which are contradictory to or deviate from our conditions of sale.
- Any alterations (amendments / additions) to these conditions shall require to be made in writing.
- Verbal collateral agreements or assurances shall be invalid unless confirmed by ourselves in writing.

II. Quotations

- Unless designated as binding in their text, our quotations shall be non binding and without obligation and shall not place us under any obligation to accept a given order.
- If, after the conclusion of the contract, modifications are called for by our customers, or if the contract is cancelled wholly or in part, all the costs and expenses and other losses thus far incurred by ourselves or to be incurred in connection therewith (e. g. lost profit) shall be chargeable to the customer. Cancellation will only be possible with our approval. This shall not affect any rights the purchaser may have to rescind or avoid the contract.

III. Prices and deliveries

- If the parties have not agreed any other price, the price shall be determined according to our price lists as valid at the time when the contract is concluded. Unless the parties have agreed anything different, the purchaser shall, in addition to all prices in accordance with the price lists, bear the costs of packaging and shipment and the turnover tax and any other public fees.
- Deliveries shall be made under the contractually agreed conditions. Unless the parties have expressly agreed anything else, deliveries shall be made ex works.
- The delivery dates or periods stated in the order confirmation shall be estimated dates or periods and shall therefore be non binding. They shall only be binding if confirmed as such in the order confirmation.
- Unless any other contractual agreement has been made, the delivery period shall begin on receipt of written confirmation of the order.
- A delivery period or date shall be deemed to have been met if the goods leave our works or warehouse or, as the case may be – if they are to be collected by the purchaser – are ready for collection prior to expiry of said date or period.
- If a non-binding delivery date or period (referred to here below in Section 6 as "non-binding delivery period") is not met, we shall be deemed to have defaulted thereon when a grace period has expired and a reminder been received from the purchaser, unless we can prove that we were not responsible for our failure to meet the non-binding delivery period or effect delivery during the grace period.

The length of the grace period shall be 1/5 of the non-binding delivery period. The grace period shall begin on the first

working day that follows the end of the delivery period. If the length of the grace period is not an exact number of full days, weeks or months, it shall be rounded off to the nearest full number of days (example: non-binding delivery period 27 days, 1/5 = 5.4 days, grace period = rounded off to 5 days).

The non-binding delivery period shall be calculated in accordance with Section III. 4.

- If a delivery period or date is not met for reasons for which we are not responsible, in particular in cases in which we ourselves have received a late or incorrect self-delivery or deliveries, the delivery period shall be extended by a reasonable period.

If we are, furthermore, unable to render our performance within said reasonably extended delivery period for reasons for which we are not responsible, we shall inform the purchaser of the fact without delay. In such cases we shall have the right to rescind the contract within a period of two weeks beginning from the moment when we inform the purchaser. Having exercised said right of rescission we shall reimburse the purchaser without delay for any counter-performance that he may already have rendered.

For the rest, the statutory rights and entitlements of the parties shall remain unaffected.

IV. Packaging

- Unless any special packaging has been agreed, the goods shall be packaged at our discretion in accordance with the standard commercial methods.
- The costs of transport packaging (e. g. euro containers, cardboard boxes or crates) shall be invoiced to the purchaser. If goods are shipped in reusable containers a rental charge or circulation fee will be invoiced. The reusable containers are to be returned immediately to the pool via the return shipment logistics system. Costs incurred by non-fulfilment of this obligation shall be invoiced to the customer. Packaging units will be taken back within the framework of and as governed by the respective statutory regulations.
- Loading costs are to be borne by the purchaser as shipment costs. If goods are loaded on pooling pallets, we shall accompany the loading procedure at the roadside in direct pallet exchange with the haulage contractor. If haulage contractors or customer's vehicles are used, the purchaser must supply intact exchange pallets. Missing pallets will be invoiced to the purchaser.

V. Shipment

- Goods will be shipped at the expense and risk of the purchaser.
- The risk shall pass over to the purchaser when the articles to be delivered are handed over to the transport company or to the purchaser himself.
- Insurance shall only be taken out at the wish and expense of the purchaser.
- Transport damage is to be reported to the haulier for inspection without delay. The purchaser must ensure that the complaint is noted in the shipment record. The shipment record provided for such cases is to be sent to us without its being necessary for us to request that it be sent.

VI. Terms of payment

- Unless any other agreement has been made, our claims shall fall due for payment in full as soon as the invoice has been received. The definitive date in determining whether or not payment has been made in due time shall be the date on which payment is actually received.
- If it becomes apparent to us after conclusion of the contract that there is a risk that the orderer may not be in a position to fulfil his performance obligations, we shall have the

right to insist that outstanding deliveries be effected only against advance payment or the provision of securities. If said advance payments have not been made or securities not provided after the expiry of a reasonable period set by ourselves, we shall be entitled to rescind all or any of the contracts affected thereby or any part thereof. The period shall be regarded as reasonable if it is at least 10 calendar days, though the purchaser shall also have the option of showing that the period was not reasonable in a given individual case. We shall in particular be entitled as above if it comes to our knowledge that the purchaser has drawn cheques not covered by sufficient funds, if bills of exchange or cheques of the purchaser's are protested, if an application is made for the institution of insolvency proceedings or if insolvency proceedings are actually instituted: the above notwithstanding our entitlement to assert further rights.

- Bills of exchange and cheques will only be accepted following special agreement and in all cases only as conditional payment. Discount charges, collection fees and all other costs shall be chargeable to the purchaser.

VII. Retention of title

- We shall reserve ownership of the delivered goods until such time as all payments arising from the existing business association with the purchaser have been received; said reservation refers to the acknowledged balance.
- The purchaser shall have the right to resell goods subject to retention of title in the normal course of business, but only under retention of title. The purchaser may neither pledge the goods subject to retention of title nor transfer title of them as security. The purchaser hereby now assigns to us as collateral all claims which accrue to him from the resale in the amount of the final invoice of our claim (inclusive of turnover tax). We hereby accept the assignment. The claims thus assigned to us in advance by the purchaser also relate to the acknowledged balance and, in the case of insolvency of the purchaser, to the existing causal balance. The cover limit of the assigned claims shall be 110% of the realisable value of the goods subject to retention of title sold and delivered in each respective case. The purchaser shall be empowered to collect the claim. Said empowerment to collect and authorisation to resell may be revoked by us if the purchaser is in breach of any of his material contractual obligations (e. g. default in payment).
- The purchaser shall inform us without delay of any attempts by third parties to take possession of the goods delivered under retention of title, doing so if possible at an early stage, when such attempts are still imminent. He shall inform third parties attempting (or intending to attempt) to take possession of the goods that the latter are our property. Any costs of interventions (e. g. § 771 of the German Code of Civil Procedure [ZPO]) shall be borne by the purchaser if the third party is not in a position to reimburse us for the judicial and extrajudicial costs.
- If the purchaser is in breach of any of his material contractual obligations, in particular in cases of default in payment, we shall have the right to repossess the purchase object and to visit the premises of the purchaser for the purpose of so doing. Rescission of the contract is, furthermore, imminent in any such repossession of the purchase object by us. We shall, after repossession, be authorised to exploit the purchase object commercially, whereby the proceeds from such exploitation are to be offset against the liabilities of the purchaser (e. g. damages) – minus reasonable exploitation costs. If the purchaser was culpable in his breach of the obligation that led to the rescission, he shall remit to us lumpsum compensation for the return transport

GENERAL SALES CONDITIONS OF VILLEROY & BOCH AG

Bath and Wellness Division - Rev. August 2016

of the purchase object in the amount of 5% of the purchase price. This sum may be set higher or lower if we can prove that the loss or damage was in fact greater, or if the purchaser can prove that it was in fact smaller.

5. We shall, for as long as a claim on our part is outstanding, have the right to request information from the purchaser at any time as to which goods delivered under retention of title are still in his possession, where they are, and to which customers the remaining goods supplied by us have been sold, said information relating to quantity, type and number. We shall also have the right to inspect the goods delivered under retention of title on any of the purchaser's premises, wherever the goods may be at any given time.

6. The purchaser shall be under obligation to treat the purchase object with due care and to carry out any necessary servicing and maintenance work at his own expense, to insure our goods against fire and theft at his own expense, and to furnish us on request with proof that said insurance has been taken out.

7. a) Any processing or remodelling of the purchase object by the purchaser will always be carried out on our behalf. If the purchase object is processed with other objects of which we are not the owner, we shall acquire co-ownership of the new thing in proportion of the value of the purchase object (final invoice amount inclusive of turnover tax) to the other processed objects at the time of processing. For the rest, the provisions governing retention of title shall apply correspondingly to the thing created by the processing.

b) As security against our claims against him, the purchaser shall also assign to us the claims which accrue to him against a third party as a result of his combining the purchase object with a plot of land.

8. If the purchaser can prove that the realisable value of the securities exceeds that of the outstanding claims by more than 10%, we shall release the surplus amount if requested to do so by the purchaser.

VIII. Product characteristics

1. We hereby draw attention to the following: On account of differing materials and manufacturing procedures, a series may feature variations in colour, often also depending on the lighting conditions.

For typographic reasons there may be deviations in colour between the illustrations in a prospectus / catalogue and the actual product itself.

Acidic and / or caustic cleansing agents may cause damage if improperly used.

Goods labelled „seconds“ will be inferior in design and quality to goods labelled „1st choice“.

2. We reserve the right to produce goods with variations in finish, colour and shape such as are usual in the trade.

3. If the purchaser makes any subsequent changes to the goods supplied by us, in particular decorations or technical modifications, he shall not be permitted to resell them under our trademark unless we have issued our prior agreement to the changes in writing.

IX. Warranty

1. Unless any other provision is made here below relating to the rights of the purchaser in cases of material and legal defects, the statutory regulations shall apply. In particular, moreover, the special statutory regulations covering final delivery of the goods to a consumer (recourse claims against suppliers in accordance with §§ 478, 479 of the German Civil Code BGB) shall remain unaffected.

2. § 377 of the German Commercial Code (HGB) shall apply in respect of the inspection of the goods and notification of defects, with the proviso that the period for giving notice of obvious defects shall be two weeks as from delivery, whilst the period for giving notice of defects that are not obviously discernible shall be two weeks as from their discovery.

3. If the goods are defective, we shall at our discretion be entitled either to rectify the defects (rectification of defects) or deliver defect-free goods (replacement delivery).

4. The purchaser shall store and handle rejected goods in the correct and proper manner.

5. We shall have the right to examine rejected goods together with an expert or other third party appointed by ourselves for the purposes of appraisal, and if necessary for the purpose of drawing up cost estimates or similar. If the purchaser fails to make the rejected goods available to us for examination within a reasonable period set by ourselves, our liability for the defects shall cease on expiry of said period.

6. In the course of supplementary performance which we are liable to carry out, we shall neither be under obligation to remove the defective thing nor to install the new thing if we were not originally under obligation to install.

7. Warranty claims on the part of the purchaser such as are oriented toward damages or compensation for futile expenditure may stand as governed in Section X („Liability“), but shall otherwise be excluded.

8. For goods which have in accordance with their normal intended use been used in a building and have caused said building to be defective, the period of limitation shall be 5 years as from delivery. For all other goods the period of limitation shall be 1 year as from delivery. In cases of intent or gross negligence or if a guarantee has been given (§ 444 of the German Civil Code BGB), and cases such as those quoted in § 479 of the German Civil Code BGB and other special statutory regulations on limitation, the statutory period of limitation will continue to apply.

9. Our liability for defects shall not extend to cover damage caused by normal wear and tear (e. g. metal abrasion or wear caused by abrasive agents), deterioration in surface properties such as was unavoidable according to the accepted engineering standards at the time when the contract was concluded, improper use of the goods, non-compliance with the instructions for cleaning, care or use, or damage caused by the purchaser or a third party or parties.

X. Liability

1. We shall be liable to the purchaser for damages and compensation for expenses, in each case as governed by the statutory regulations, in the following cases (here below in Section X: „Liability“): liability under the German Product Liability Act (ProdHaftG); intent or fraudulent misrepresentation; gross negligence; injury to life, limb or health; cases in which a guarantee has been given by ourselves; cases such as those quoted in § 288 Para. 6 Sentence 1 of the German Civil Code BGB and any other cases of statutory compulsory liability.

2. We shall also be liable to the purchaser for damages in case of culpable breach of material contractual obligations as governed by the statutory regulations. Material contractual obligations within the meaning of this clause are all obligations the breach of which jeopardises the achievement of the object of the contract and all obligations without the performance of which the contract cannot properly be fulfilled and in compliance with which the purchaser may routinely trust. Having said that, if a material contractual obligation is breached in a way that involves only ordinary negligence, entitlements of the purchaser to claim for damages shall, as regards the amount, be restricted to typical foreseeable loss or damage.

3. If we default on or fall behind with our performance, the purchaser shall be entitled to claim against us on the basis of that default if his claim is for a contractual penalty or lump-sum compensation incurred within a supply chain in another contractual relationship in that supply chain, but only if he informed us expressly about the risk of such loss or damage prior to the conclusion of the contract. If not, the purchaser shall be entitled to claim for a contractual pen-

alty or lump-sum compensation owed and paid by him as loss or damage caused by default only in the amount of a maximum of 5% of the net value of our order. The above shall apply correspondingly if the purchaser makes a claim against us for indemnification in respect of such contractual penalties or lump-sum compensation.

4. For the rest, there shall be no entitlement of the purchaser to claim for damages for whatever cause in law.

5. If our liability is restricted or excluded in accordance with the above provisions, the same shall apply to the personal liability of our legal representatives, employees, non-managerial staff and vicarious agents.

6. The entitlement of the customer to claim for damages shall fall under the statute of limitation within the statutory periods of limitation, the statutory regulations also applying as regards the beginning of said periods.

XI. Offset, right of retention

1. The purchaser shall only be entitled to offset against due claims which are uncontested or have been established as legally established as final.

2. The purchaser shall only be entitled to a right of retention in respect of legally enforceable or uncontested claims.

XII. Industrial property rights

All industrial and intellectual property rights relating to our products, shapes, illustrations, installation instructions, reports, data and other records and documents shall remain the property of ourselves or, as the case may be, our respective licensors. No rights of use or exploitation shall be granted to the purchaser relating to said industrial or intellectual property rights.

XIII. Applicability of German law, place of jurisdiction

1. The law of the Federal Republic of Germany shall apply, there being no recourse to the UN Convention on Contracts for the International Sale of Goods (CISG).

2. If the purchaser is a businessman who concludes the contract in the context of a commercial transaction, a legal entity under public law or a separate asset under public law, the place of jurisdiction for all disputes arising from or in connection with the contract shall be the registered office of the Villeroy & Boch group company which concluded the contract. If that company does not have a general jurisdiction venue in the Federal Republic of Germany, the place of jurisdiction shall be the registered office of Villeroy & Boch AG.

Villeroy & Boch

GERMANY

Villeroy & Boch AG

Unternehmensbereich Bad und Wellness

Hauptverwaltung

66693 Mettlach

Telefon +49 68 64 81 - 0

Fax +49 68 64 81-14 84

WWW.VILLEROYBOCH.COM/OUTDOORWHIRLPOOLS